

# Product Datasheet



## Hard-Mounted Hollow Retroreflector - HMHR™

Parallel incident light that hits the HMHR will be returned with great accuracy to the light source, regardless of the HMHR's physical orientation.

The HMHR is constructed of three first-surface mirrors assembled by a proprietary process into a mutually-orthogonal inside corner. The mirrors can be coated for maximization over a spectral range, from UV to far IR. This hollow configuration eliminates material absorption and chromatic aberration. The mirror assembly of the HMHR is mounted on an Invar mount. (5.0"/127mm unit comes with aluminum mount). Invar is a low-expansion (CTE 0.75 ppm/K) alloy of iron and nickel that is used when control of thermally-induced dimensional change is required.



### Specifications

Substrate	Pyrex
Housing material	Invar
Surface Flatness	$\lambda/10 - \lambda/20$ @633nm
Surface Quality	80-50 Scratch-Dig
Beam Deviation	0.5 – 30.0 Arcsecond

### Coating Types

- A – Enhanced Aluminum
- B – IR Enhanced Aluminum
- C – Unprotected Aluminum
- D – UV Enhanced Aluminum
- E – Protected Silver
- G – Protected Gold
- H – Unprotected gold
- I – Protected Aluminum

The HMHR offers properties which make it especially suitable for critical applications, such as Michelson interferometers. The mount maintains stability of the distance between the apex of the corner cube and the back surface of the mount, as well as concentricity of the apex with respect to the mounting thread. HMHRs can also be provided in matched pairs for better modulation. Standard HMHR mirror coatings are aluminum, silver and gold, in both bare metal and with protective overcoats. All protected PLX coatings meet MIL-SPEC durability and adhesion requirements. Unprotected metallic coatings are especially suited to interferometric applications. Custom coatings available.

#### Note:

**Beam Deviation** is the maximum deviation from parallelism, expressed in seconds of arc, of any single return beam from any of the 6 sub-apertures of the retroreflector, when the retroreflector is fully-illuminated.

**Exiting Wavefront** is the resultant maximum peak-to-valley wavefront deformation from a fully-illuminated retroreflector, where  $\lambda = 633\text{nm}$ . (See next page)

Beam deviation and exiting wavefront are interrelated, and it is only necessary to specify one.

Certain high accuracy models may be heavier than indicated here. Check with us for actual weight.

#### Important Notice

This datasheet contains typical information specific to products manufactured at the time of its publication. All rights reserved. All material herein is the property of PLX Inc. and shall not be reproduced without the written permission of PLX Inc.

# Product Datasheet

## Hard-Mounted Hollow Retroreflector - HMHR™



### Outline Drawings

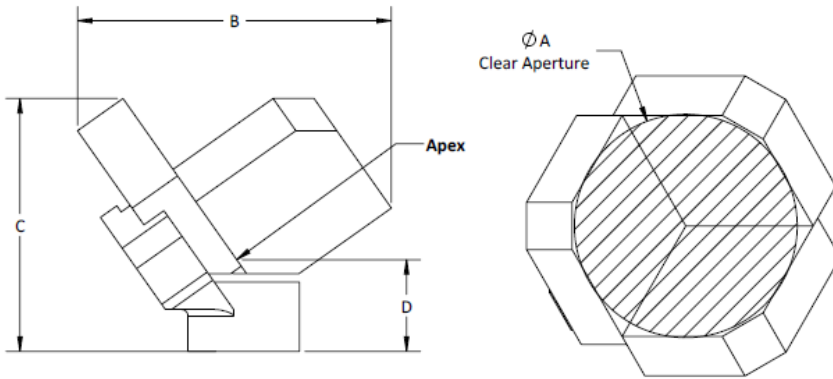

### Coating Types

SUFFIX	WAVELENGTH RANGE (nm)	AOI 55° PER-SURFACE REFLECTANCE (AVG)
A	400 - 700	93%
B	600 - 1,600	89%
C	225 - 10,000	90%
D	225 - 700	89%
E	450 - 10,000	96%
G	650 - 16,000	97%
H	650 - 20,000	97%
I	400 - 750	87%

Item	Accuracy (arc.sec.)	ØA (in/mm)	B (in/mm)	C (in/mm)	D (in/mm)
HM-10	1.0 – 30.0	1.00/25.40	1.41/35.77	1.13/28.75	0.41/10.42
HM-15	0.5 – 30.0	1.50/38.10	1.93/49.05	1.57/39.79	0.52/13.24
HM-20	0.5 – 1.0	2.00/50.80	2.55/64.81	2.11/53.56	0.71/17.92
HM-20	2.0 – 30.0	2.00/50.80	2.48/62.94	1.92/48.88	0.52/13.24
HM-25	0.5 – 1.0	2.38/60.33	3.00/76.32	2.38/60.45	0.71/17.92
HM-25	2.0 – 30.0	2.38/60.33	2.93/74.45	2.20/55.77	0.52/13.24
HM-50	0.5 – 1.0	4.56/115.89	5.52/140.09	4.54/115.23	0.84/21.38
HM-50	2.0 – 30.0	4.56/115.89	5.47/138.85	4.42/112.30	0.73/18.44

Detailed coating curves are available in the following pages.

### Custom Configurations

#### Custom configurations for specialized applications

PLX engineers can create a custom HMHR for your application. Potential variations include: smaller and larger apertures; modified hard mounts to meet your interface; super-critical accuracies; dielectric mirror coatings for high-powered lasers; and units able to withstand military and space environments.

### Specifications

Item	Beam Deviation (arc.sec.)	Exiting Wavefront (p.v.633nm)	Weight (grams)
HM-10	1.0 – 30.	0.15 - 3.50	25
HM-15	0.5 – 30.0	0.10 - 5.25	45
HM-20	0.5 – 30.0	0.15 – 7.00	90 - 110
HM-25	0.5 – 30.0	0.25 – 9.00	110 - 141
HM-50	0.5 – 30.0	0.45 – 18.00	551 - 780

# Product Datasheet

## Hard-Mounted Hollow Retroreflector - HMHR™



### Coating Curve

AOI 55°

**A - Enhanced Aluminum Coating 400-700 nm**

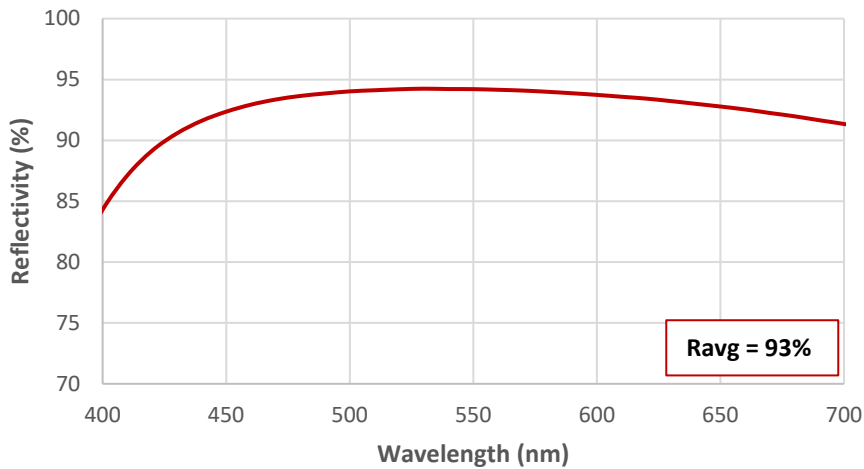

**B - IR Enhanced Aluminum Coating 600-1600 nm**

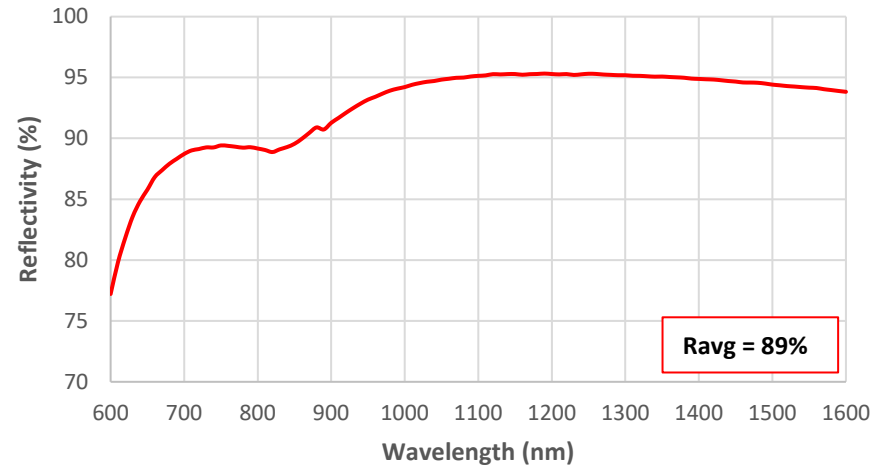

**C - Unprotected Aluminum Coating 225-10000nm**

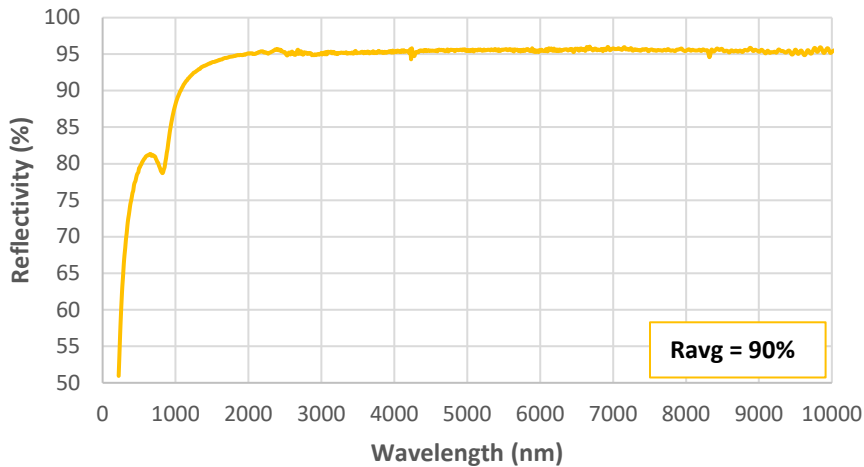

**D - UV Enhanced Aluminum Coating 225-700 nm**

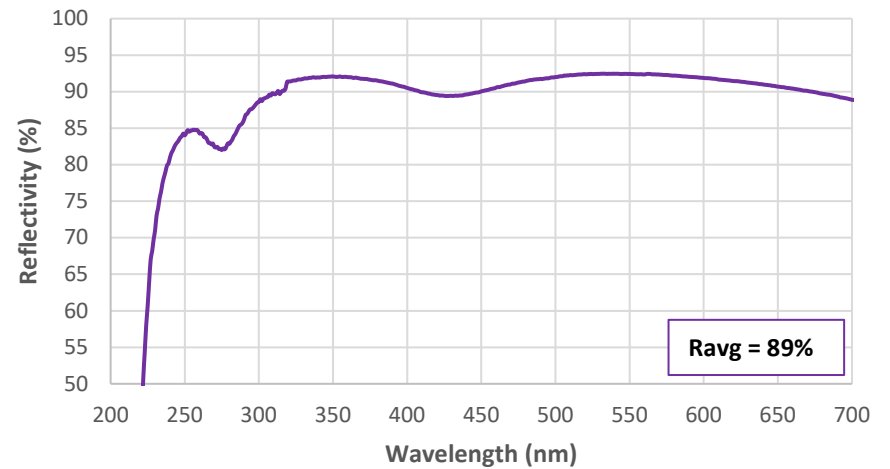

**Note:** Coatings meet Ravg requirement, but coating curves are for reference as R(λ) may vary ± 2% per lot.

# Product Datasheet

## Hard-Mounted Hollow Retroreflector - HMHR™



### Coating Curve

AOI 55°

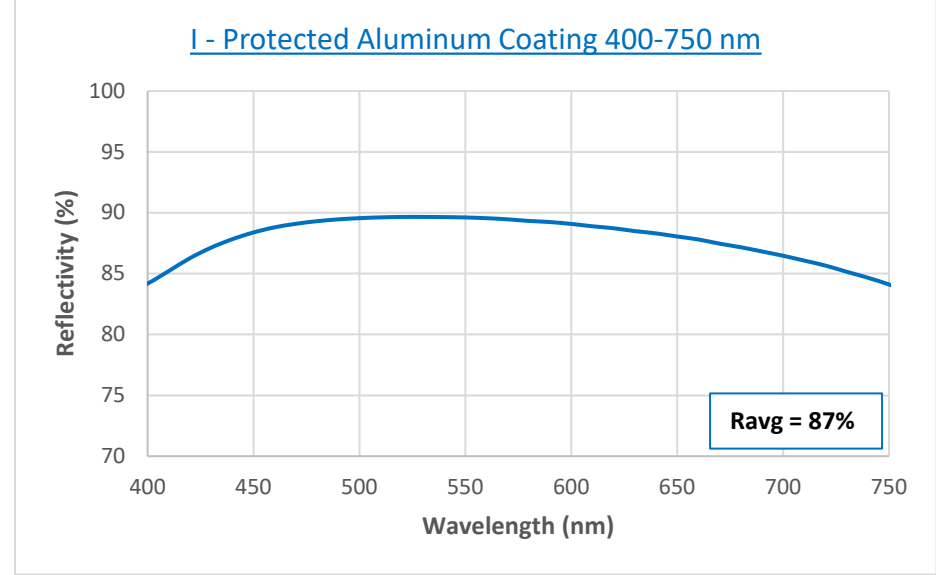
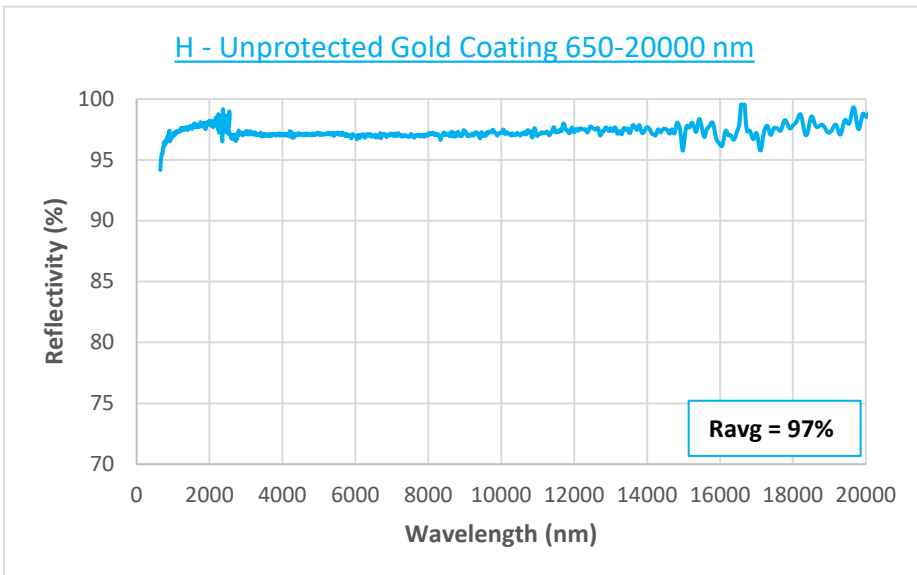
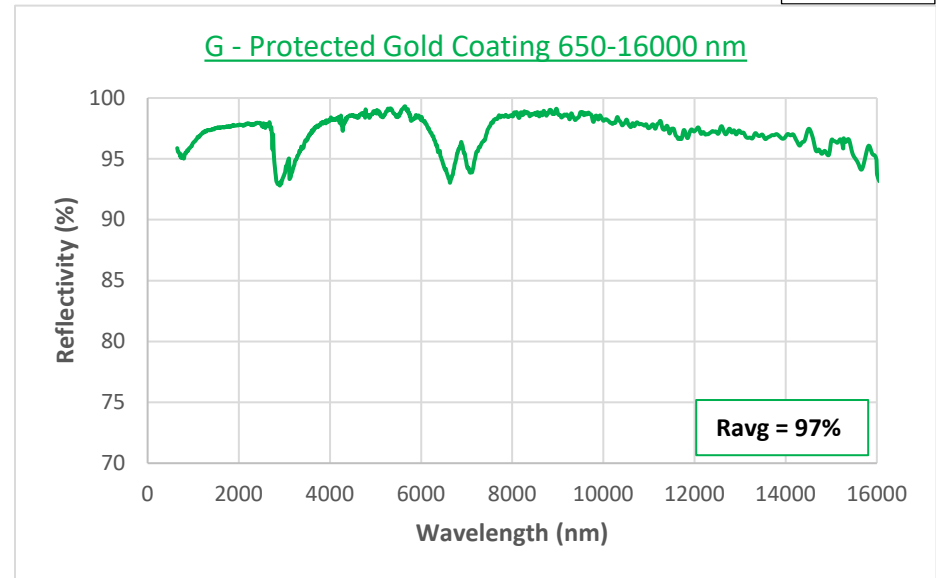
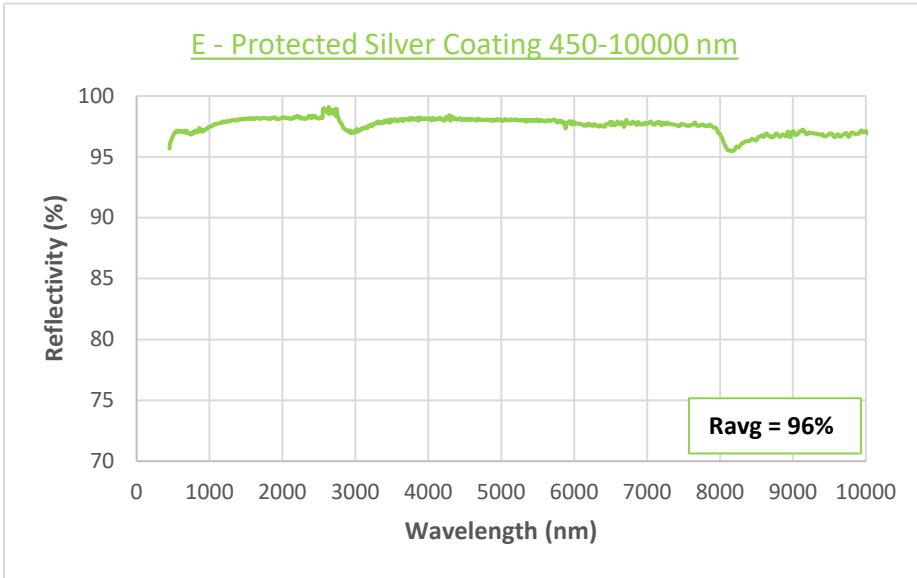

**Note:** Coatings meet Ravg requirement, but coating curves are for reference as  $R(\lambda)$  may vary  $\pm 2\%$  per lot.